



**HÄGER
WERKEN**

Dentalprodukte weltweit
Dental Products Worldwide



The Catalogue

Lab No. 13





Dentalprodukte weltweit
Dental Products Worldwide

Häger & Werken GmbH & Co. KG
Ackerstraße 1 · 47269 Duisburg · Germany
Telefon +49 (203) 99269-0
Fax +49 (203) 299283
E-Mail info@hagerwerken.de
Internet www.hagerwerken.de



Häger Worldwide, Inc.
441-19th S.E.
Hickory N.C. 28602, USA
Tel.: (800) 328-2335, Tel.: (001) 828 624 3300
Fax: (800) 573-9392, Fax: (813) 926-7473
E-Mail: contact@hagerworldwide.com
Website: www.hagerworldwide.com
General Manager: Marc Schneider

Please dial directly: +49 (203) 99 269 + extension



Mob(HK): +852-9168 0419
Mob: +86-138 1780 6110
Tel(HK): +852-2622 2796
Tel: +86-21-6210 3519
E-Mail: kate@hagerasia.com.hk

Shanghai Office
RM.11F Zhongxi Mansion
No.121-123 Jiangsu Road
200050 Shanghai China
Tel: +86-21-5239 8205, -8206, -8207
Fax: +86-21-5239 8135
E-Mail: info@hagerasia.com

Hong Kong Office
Unit 11, 6/F, Hung Tai Industrial Building,
37-39 Hung To Road, Kwun Tong,
Kwloon, Hong Kong
Tel: +852-2622 2795
Fax: +852-2622 2503
E-Mail: info@hagerasia.com.hk

General Manager: Kate Tsui



Häger Polonia Sp. z o.o.
Ul. Obrońców Poczty Gdanskiej 10
52-204 Wrocław
Telefon 1: +48 - 71-368-71-66
Telefon 2: +48 - 71-368-71-37
Fax: +48 - 71-368-10-21
E-Mail: biuro@hager.com.pl
General Manager: Ania Biernacka

Service Export

Susanne Bah -45
s.bah@hagerwerken.de

Saskia Wilmschen -42
s.wilmschen@hagerwerken.de

Anneli Heyse -43
a.heyse@hagerwerken.de

Julia Heckmann -47
j.heckmann@hagerwerken.de

Export

Jörg Zensen
(European Sales Manager)
+49 (203) 99 269 40
j.zensen@hagerwerken.de

Marcus van Dijk
(European Sales and Marketing Director)
m.van.dijk@hagerwerken.de

Simone Krug
(Sales Manager Austria/Switzerland)
s.krug@hagerwerken.de

Klaudija Andrijašević
(Sales Manager Croatia)
ka@hagermiradent.hr

Nurhan Sariaydin
(Sales Manager Turkey)
n.sariaydin@hagerwerken.de

Jonathan Vigreux
(Sales Manager France)
j.vigreux@hagerwerken.de



A apterset	20
Airsonic Absorbo Box	23
Airsonic Adapter	23
Airsonic Alu-Oxide	23
Airsonic Mini Sandblaster	23
Algilock Cleaner Plus	27
Anti-Stress Tooth	35
Aperture Guide Pins	18
Armatron Pro	12
Artiholder	13
Astro Clean	34
Atomic B	21
Atomic Spare Parts	22
B alance	17
Balance Distance Rings	19
Balance Jüde Set-Up Table	18
Balance De Luxe	17
Balance Spare Parts	19
Balance Facebow	20
Balance Split-Cast F	22
Balance Pillar Set	19
Blue-Flame 1500	12
Bravo Portable II	25
Bravo TD III	25
C arat	05
Carat Biopaque	06
Carat Biopaque Color Shades	06
Carat Ecoline	07
Carat Glass Mixing Plate	05
Carat MP Mass Portioner	05
Carat Color Shades	06
CC-Shield	34
Ceram-Brush „ER“	08
Ceram-Brush „K“	08
Ceram-Brush „RK“	08
Cerami-Cut	13
Combitec	16
Combitec Support Device	20
Combitec Facebow	20
Condyles	18
Corund SC	13
D ento Box I + II	29
Dipol	09
F lexible Bite Fork	20
H &W Classic	33
H&W Featherlight	33
H&W OTG	33
H&W Panorama	33
I ncisal Table	16/18
Incisal Table Individual	16/19
Incisal Guide Pins	18
Individual Condyles	18
I-Prox Care Set	31
I-Prox P	31
K isag Burner	12
Koni-Cast	11
Konoval	11
M ctooth Clip	28
McTooth Mirror	26
Membranbox	04
Membranbox XXL	04
Mirabol	10
Mirabol Spatula	10
Mira-Brush Ceram	08
Miracast	11
miradent Demo Box	30
Mirafloss Implant chx	29
Mirapont	10
Mirapont Agent Plus	10
Mirapont Silifit	10
Mirapor	09
Miratray Implant	04
Mirator 2000	25
Miratorch	12
Mirawet	27
N on-Stick	11
O cclu Spray Plus	15
Orange-Solvent	27
Orbatec Ceramic Oven	07
P ic-Brush Replacement Brushes	30
Pic-Brush Intro Kit	31
Pic-Brush IP Probe	30
Pic-Brush Set	31
Plaster Spatula RS	10
Praxipol PS	25
Praxipolish	26
Praxipolish Plus	26
Protho Box	29
Protho Brush De Luxe	29
Protho Clean	27
Proto-Cam	34
Protrusion	16
R etrusion	16
S et-Up Device/Calotte	22
Mounting Plates	17
Mounting Plates (Atomic B)	21
Set Of Mounting Plates (Combitec A)	16
Solderfix	13
Speed Labolight	24
Speed Multipol	24
Speedo-Clean	26
T ong-Clin De Luxe	28
Tong-Clin Gel	28
U vex I-VO	32
uvex Skyguard	32
uvex Super-Fit	32
uvex Super-Fit UV	32
uvex Super OTG	34
V ernax 100	14
Vernax Antagon	14
Vernax Colloidal Graphite	13
Vernax G	14
Vernax S	14
Vernax Thinner	14
Verticast	11
X ylitol Chewing Gum	35
Xylitol Powder	35
Z ahnpick	28



More detailed information
(on this product) is available

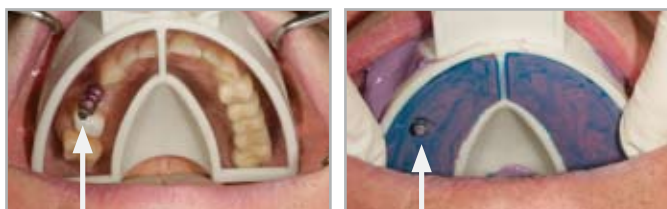

Ready for
immediate use



SCAN ME



Video

Miratray® Implant

Implant impression tray with foil technique

- Saves you and your patient an additional patient visit and laboratory cost
- Controllable and safe impression taking with clear view of implant posts
- Clean impression is taken as foil meets precisely at implant posts
- No overflowing impression material
- Customisable, user-friendly and cost-effective
- Available in three sizes for maxilla and mandible (dentulous and edentulous)
- Suitable for all implant impression materials and implant systems

Article	Size	Content	REF
Intro Kit 6 x 1 piece (Upper/Lower jaw small, medium, large)			101 250
Upper S1	small	6 pcs.	101 251
Upper S2	medium	6 pcs.	101 252
Upper S3	large	6 pcs.	101 253
Lower I1	small	6 pcs.	101 254
Lower I2	medium	6 pcs.	101 255
Lower I3	large	6 pcs.	101 256

The novel impression tray with patented foil technique is a development of the team Prof. Dr. Spiekermann and Dr. Haselhuhn (University Aachen, Germany) and Dipl.-Ing. K. Reimers (TH Aachen). An individual impression tray in a matter of seconds, high-precision and big cost savings, without laboratory.



Small (W x H x D):
4 x 1.9 x 4 cm



Medium (W x H x D):
9.5 x 2.3 x 9.5 cm

Large (W x H x D):
14 x 7 x 9 cm



Stackable



Membranbox

Transport and storage box with inside membranes

- Two membranes hold the contents visible and careful in place
- Safety lock
- Long durability by high-quality material
- No rattling, two membranes are fixing the smallest parts absolutely careful

Description	REF
Large: For 1 model denture, larger objects etc.	304 601
Medium: For bridges, partial dentures etc.	304 602
Small: Set of 12 for crowns, inlays etc.	304 603

Inner dimensions:
(W x H x D): 19.2 x 4.8 x 9.2 cm



Membranbox XXL

- For two dentures
- Stackable

Description	REF
Membranbox XXL	304 605



Carat®

Metal ceramics for the highest aesthetic demand

- Strong adhesion to all commonly used alloys, very good modeling properties, high stability as well as form and contours stability
- Excellent shade combination with single compounds due to naturalness and degree of transparency of the dentin and glaze masses
- Reliable physical characteristics
- If space is restricted, an opacious dentine will also provide an exact color

Basic assortments available upon request.

With our **Intro-Kits** you have the possibility to pile up a color from the basic mass up to the brilliant firing.

Contents: Biopaque UN color paste (in VA 3, VA 3.5, BIO 21 and BIO 31), opaque fluid, litter crystals transparent, the respective dentin, opaque dentin and glaze masses, transpamass T, glaze mass, modeling fluid UNF and insulating fluid.

Description	REF
Carat Intro-Kit V-A3	604 523
Carat Intro-Kit V-A3,5	604 524
Carat Intro-Kit Bio 21	604 525
Carat Intro-Kit Bio 31	604 526
Carat brush, red for basic compounds, 12er set	604 212
Carat brush, blue for color compounds, 12er set	604 214



Carat® MP Mass Portioner

Adjustable dosing instrument

- For the gramme-precise dosing of ceramic powders
- Four units: 0.1 g, 0.2 g, 0.4 g and 0.8 g
- Material: Hardened stainless steel with titanium nitride coating

Description	REF
Carat MP	304 028

Carat® Glass Mixing Plate

Glass plate for the mixing of ceramic compounds

- Size: 12.5 x 8 cm

Description	REF
Carat Glass Mixing Plate	604 211

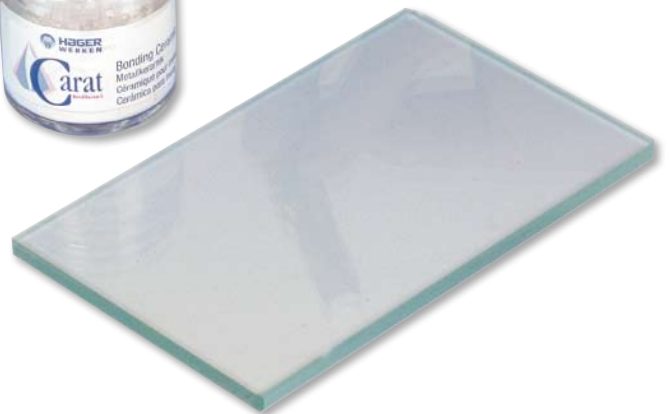

Carat® Biopaque® – Premixed

Ceramic compound with powdering crystals

- Base and color pastes in a spreadable consistency
- No mixing, condensing and blotting necessary
- Powdering crystals result in a thin, even layer
- Excellent color brilliancy and natural light reflection due to the powdering crystals
- Available in Biodent and V colors in syringes

Description	REF
Low cost Test Kit (A3) (1 color A3 + crystal-scatter bottle + funnel crystal collector)	604 518
9-color-set in syringe form (A1/A2/A3/A3,5/B2/B3/C2/D2/D3)	604 568
Bottle crystal-scatter available in 3 colors: Dark	604 205
Light	604 206
Transparent	604 207



Funnel-collectors:
3 colors for crystals



Crystal-scatter bottle



Premixed Carat Biopaque compound available in syringes: 18 Biodent colors + 16 V colors

Carat® Biopaque® Color Shades (no picture)

To mark characteristics in the Biopaque compounds

Description	REF
MF 01 yellow	604 442
MF 02 red	604 443
MF 03 blue	604 444
MF 04 white	604 445
MF 05 grey	604 446
MF 06 orange	604 447
MF 07 brown	604 448
MF 08 dark yellow	604 449

SCAN ME



Video



Carat® Color Shades

Especially for dental ceramic work on the tooth surface and to individualize the surface in colors

- Suitable for Carat metal ceramics and Carat Ecoline

Description	REF
Carat Color Shade 1, 3 g, red	604 502
Carat Color Shade 2, 3 g, blue	604 503
Carat Color Shade 3, 3 g, dark yellow	604 505
Carat Color Shade 4, 3 g, white	604 507
Carat Color Shade 5, 3 g, khaki	604 509
Carat Color Shade 6, 3g, orange	604 511
Carat Color Shade 7, 3 g, dark orange	604 512
Carat Color Shade 8, 3 g, black	604 515
Glaze material	604 248
Color shade fluid E, 15 ml	604 219
Color shade fluid E, 100 ml	604 220
Color shade fluid O, 15 ml	604 221



Carat® Ecoline

Time saving, easy handling for all standard works – does not require any specific techniques

- Simple and clear assortment: 16 dentins in VIT colors, 5 enamels and 1 overglaze powder
- Very good compatible with all VIT colors
- Suitable for all high fusion alloys, especially for all standard non-precious alloys
- The "forgiving" material: Outstanding thermal stability and it tolerates for example unstable temperature during firing process
- Can be combined with the colors, shoulder materials and other accessories of the Carat system

Description	REF
Dentin A1, 50 + 5 g	604 530
Dentin A2, 50 + 5 g	604 531
Dentin A3, 50 + 5 g	604 532
Dentin A3,5, 50 + 5 g	604 533
Dentin A4, 50 + 5 g	604 534
Dentin B1, 50 + 5 g	604 535
Dentin B2, 50 + 5 g	604 536
Dentin B3, 50 + 5 g	604 537
Dentin B4, 50 + 5 g	604 538
Dentin C1, 50 + 5 g	604 539
Dentin C2, 50 + 5 g	604 540
Dentin C3, 50 + 5 g	604 541
Dentin C4, 50 + 5 g	604 542
Dentin D2, 50 + 5 g	604 543
Dentin D3, 50 + 5 g	604 544
Dentin D4, 50 + 5 g	604 545
Fusion alloy bright, 50 + 5 g	604 546



Video



Fusion alloy medium, 50 + 5 g	604 547
Fusion alloy dark, 50 + 5 g	604 548
Fusion alloy extra bright, 50 + 5 g	604 549
Fusion alloy transparent, 50 + 5 g	604 550
Glaze material, 15 g	604 551
Fluids:	
Color shade fluid E, 15 ml	604 219
Color shade fluid E, 100 ml	604 220
Color shade fluid O, 15 ml	604 221
Modeling fluid U, 100 ml	604 216
Modeling fluid U, 500 ml	604 218
Modeling fluid UNF, 100 ml	604 217
Ceramic isolation, 10 ml	604 222
Ceramic isolation, 50 ml	604 223
Carat Ecoline Basic Kit with 4 VIT-colors	604 552
Carat Ecoline Full Kit with 16 VIT-colors	604 553



Orbatec® Ceramic Oven

Proven microprocessor-steered ceramic oven 220 V

- High-performance 16 bit microprocessor
- Easy-to-handle input decoder for all functions
- "Flash-Type-Memory" for online updating
- Big, blue illuminated LCD display for a clear view of the program guidance
- 79 individually adjustable programs (incl. 15 sub-functions per program for the precise control of the vacuum and the cooling speed)
- Suited for any ceramic mass

Technical data:

Size (B x H x T):	39 cm x 51 cm x 44 cm
Weight:	25 kg
Voltage:	220 – 230 V (AC)
Power:	1050 W
Pump power:	(max.) 500 W
Fuse protection:	10 A
Max. temp.:	1200 °C
Grades:	2 – 200 °C
Programs with auto-calibration:	79

Description	REF
Orbatec ceramic oven	401 160
Vacuum pump	401 161
Vacuum pump oil-free	401 162



Ceram-Brush "K"

Modeling brush for ceramics (size 8) - pictured

- High quality "pure-Kolinsky" modeling brush
- High resistance, long life brush
- Firm and fine brush end with high spring action
- A modeling brush for the highest demands
- Short, black painted handle with silver clamp

Description	REF
Ceram-Brush K (size 8)	304 213

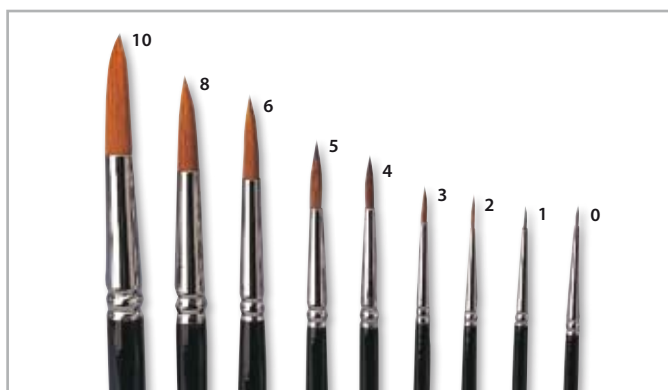

Mira-Brush Ceram

Acrylic hair brush for ceramics

- Long lifetime, tapering form
- High reset- and spring action
- Available in 10 sizes

Description	Size	Content	REF
Mira-Brush Ceram	0	1	304 221
Mira-Brush Ceram	1	1	304 222
Mira-Brush Ceram	2	1	304 223
Mira-Brush Ceram	3	1	304 224
Mira-Brush Ceram	4	1	304 225
Mira-Brush Ceram	5	1	304 226
Mira-Brush Ceram	6	1	304 227
Mira-Brush Ceram	8	1	304 228
Mira-Brush Ceram	10	1	304 229
Mira-Brush Ceram	12	1	304 230
Mira-Brush Ceram	Set	10	304 220



Ceram-Brush "ER" – "Finger form"

Modeling brush for ceramics with ergonomic handle

- High quality "pure-Kolinsky" red marten modeling brush
- Excellent guiding by ergonomic handle
- Fine and strong brush tip with high spring action
- Long lifetime
- High resistance

Description	Size	Content	REF
Ceram-Brush ER	00	1	304 250
Ceram-Brush ER	0	1	304 251
Ceram-Brush ER	1	1	304 252
Ceram-Brush ER	2	1	304 253
Ceram-Brush ER	3	1	304 254
Ceram-Brush ER	4	1	304 255
Ceram-Brush ER	5	1	304 256
Ceram-Brush ER	6	1	304 257
Ceram-Brush ER	8	1	304 258
Ceram-Brush ER	10	1	304 259
Ceram-Brush ER	12	1	304 260
Ceram-Brush ER	Set	11	304 261

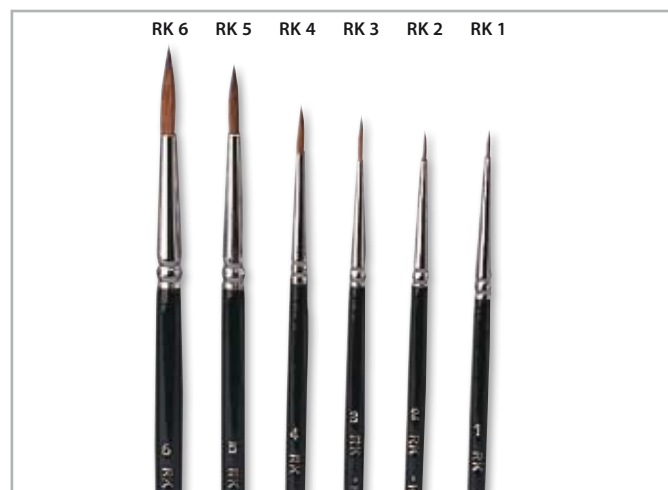

Ceram-Brush "RK"

Natural hair brush-RK (red marten hair)

- For the modeling, covering, opaueing and cleaning of crowns, for painting and characterizing
- Available in 6 sizes (tapering form)

Description	Content	REF
Ceram-Brush RK-1	1	304 203
Ceram-Brush RK-2	1	304 204
Ceram-Brush RK-3	1	304 205
Ceram-Brush RK-4	1	304 206
Ceram-Brush RK-5	1	304 207
Ceram-Brush RK-6	1	304 208
Ceram-Brush Set	6	304 201



Dipol®

Proven wetting agent for all phosphate and plaster investment materials

- For exact and clean surface
- Wax-degreasing, reduces the surface tension of wax
- Dipol builds a molecular bridge between water-repellent wax and investment compounds which can flow bubble-free and accurately adapting to the wax. Clean, smooth surfaces
- It contains no delaying chemicals which can lead to rough surfaces
- Dipol is also suited excellently as wetting agent on impressions of silicone, polyether etc. for a trouble-free outpouring with plaster
- Free of formaldehyde and alcohol
- Pumping atomizer with micro fine spray fog

Description	Content	REF
Set with 1 l bottle (1,000 cc) + 1 pump bottle (empty)	1 liter	605 044
Pump bottle (filled)	100 ml	605 043
Pump bottle (empty)	(leer)	605 045



Big: 1,000 cc bottle (full) comes with pump bottle small (empty)



Mirapor®

Isolates plaster from plaster

- Without any film build-up, not silicon binding
- Exact, very simple separation
- Plaster parts release without aid
- Surfaces are sealed against dirt and water
- Plaster surfaces can be polished brilliant with a brush or a cloth
- Without fuel gas, formaldehyde-free

Description	Content	REF
Set: 1 l bottle (1,000 cc) + 1 pump spray bottle (empty)	1 liter	605 113
Pump spray bottle (filled)	100 ml	605 119
100 ml pump spray bottle (empty)		605 114



See page 27 – Mirawet liquid for plaster



Mirapont®

A pale, highly exact special plastic for stumps, hard plastic models and single teeth

- Very thin and slightly fluent material
- Both liquids (components A and B, relation 1:1) are mixed within 30 sec
- Can be poured into silicone, alginate, reversible hydrocolloids and thermoplastic
- After 90 min. it can be sawed, milled and polished

Description	REF
Mirapont 500 g (small starter set) Contents: 250 g liquid A, 250 g liquid B, 2 dosage bottles A and B, 200 ml Agent Plus, 100 g Silifit, 5 measuring mugs, 1 mixing mug with pouring spout, 2 big mixing spatulas, 5 small mixing spatulas, one-way gloves	203 010
Mirapont 1,000 g Contents: 2 x 250 g liquid A, 2 x 250 g of liquid B, 2 dosage bottles A and B, 200 ml agent plus, 100 g silifit, 5 measuring mugs, 1 mixing mug with pouring spout, 2 big mixing spatulas, 5 small mixing spatulas, one-way gloves	203 011



Mirapont® Agent Plus

- Isolates Mirapont against wax
- Isolates polyether and polysulfide materials against Mirapont

Description	Content	REF
Mirapont Agent Plus	200 ml	203 016

Mirapont® Silifit

Special block-out material, kneadabler

Description	Content	REF
Mirapont Silifit	250 g	203 015



Mirabol®

Green, flexible mixing bowls

- Easy to clean, for Alginat, gypsum etc.
- Special high-quality, flexible material in three dimensions / heights available

Description	Ø	Height	REF
Nr. 1 (large)	12 cm	9 cm	304 331
Nr. 2 (x-large)	13 cm	11 cm	304 332
Nr. 3 (jumbo), dark green	17 cm	13 cm	304 333

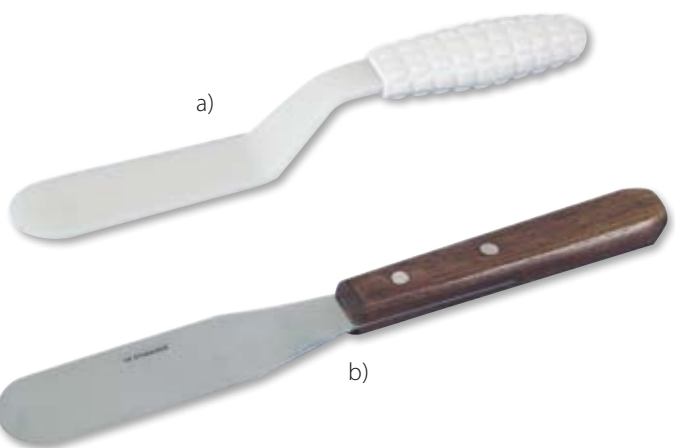

Mirabol® Spatula

Plaster and alginate plastic mixing spatula

- Optimal angle, ergonomic handle

Description	REF
a) Mirabol Spatula (white)	304 316

Plaster Spatula RS

Solid stainless steel spatula with plastic handle

Description	REF
b) Plaster-Spatula RS	304 314



Miracast®

Model former

- Vertically elevated retention marks
- Low-priced, available in 3 sizes for uppers and lowers

Description	REF lower	REF upper
Miracast, small	203 066	203 065
Miracast, medium	203 067	203 068
Miracast, large (fits lower + upper)		203 069



Koni-Cast

Casting rings in conical shape

- High quality stainless steel
- Height 55 mm, in 4 sizes
- X1:** small ∅ on top 32 mm, ∅ below 30 mm
- WM:** (for Whipmix) ∅ on top 40 mm, ∅ below 38 mm
- X3:** ∅ on top 50 mm, ∅ below 48 mm
- X6:** ∅ on top 67 mm, ∅ below 65 mm
- Bigger forms available upon request
- Also available silicone bases or the flexible multi base for all rings (not pictured)

Description	REF
X1	304 031
WM	304 032
X3	304 033
X6	304 034
Basis X1 (Bene silicone)	304 035
Basis WM (Bene silicone)	304 036
Basis X3 (Bene silicone)	304 037
Basis X6 (Bene silicone)	304 038
Multi-Base fitting for all sizes	304 039



Non-Stick

Special silicone spray

- Isolation, protection and care spray
- Essential for the care of articulators
- Condyles, balls and all movable parts are gliding very easily
- For the surface isolation of precision norm maters against plaster
- Prevents sticking of plaster on trimmers, flasks and elastic layers etc.
- Makes door and devices hinges smooth running

Description	Content	REF
Non-Stick	400 ml	554 206



Konoval

Casting rings in oval shape

- Oval form guarantees that the warmth achieves the model steadily from all sides
- For an optimal casting quality
- High saving of time by steady cooling down
- Approx. 50 % saving of invested compounds
- In two dimensions with suitable base available:
- Normal: H 55 mm, B 20 mm, L 40 mm
- Large: H 55 mm, B 30 mm, L 40 mm

Description	Size	REF
Konoval, casting ring	normal	304 050
Konoval, casting ring	large	304 051
Konoval Base	normal	304 052
Konoval Base	large	304 053

Verticast

Casting rings

- Stainless steel, not conical



Description	Height	∅	REF
X1	55 mm	30 mm	304 054
X3	55 mm	50 mm	304 055
X6	55 mm	65 mm	304 056
X9	55 mm	75 mm	304 057

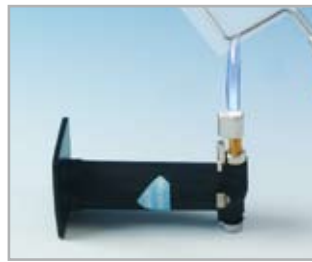

Miratorch®

Low-priced small dental burner for dentist and lab

- Small, handy burner (170 g)
- Easy setting and regulation of temperature and flame, variable adjustable
- Burner temperature 1,300°C, burning time approx. 60–70 minutes
- Refillable with APT Gas

Description	Content	REF
Miratorch	–	401 010
APT Gas	200 ml	605 143



Armatron Pro

Convenient burner for one-hand operation

- Activation of the ignition with the hand heel
- Unique, extra reliable ignition system
- Variable adjustable flame from approx. 800–1.300 °C
- Mobile handling allows working with the flame upside down
- Refillable with APT Gas (see above)

Description	REF
Armatron Pro	401 002



Kisag Burner (classical Swiss burner)

Gas burner for practice and lab

- Flame temperature adjustable from approx. 750–1,150 °C
- One filling for 5–6-hour burning time
- With the Swiss approval SVGW (conform to GS signs)
- Refill with Kisag Gas only

Description	REF
Burner incl. 400 ml Kisag Gas	401 005
Kisag Gas, 400 ml	605 140



Blue-Flame 1500

Handy burner for practice and lab, classical model

- Simple, practical one-hand operation
- Automatic and dependable ignition
- Stable freestanding burner, only 15 cm small
- Flame also in the temperature variable adjustable from approx. 800–1.300 °C, max. burning time approx. 35 minutes
- Refillable with APT Gas (see above)

Description	REF
Blue-Flame 1500	401 006



Solderfix – The third hand

Soldering aid

- Two holding arms with ball joints allow an optimal positioning of the objects to be soldered
- The base plate is equipped with a fire-resistant and asbestos-free fiber glass plate
- Measurements: 230 x 152 mm

Description	REF
Solderfix	304 451



Vernax® Colloidal Graphite

Special graphite in liquid form

- With integrated brush easy to apply
- Solder does not flow about the graphite limitation
- No lunker building within the joint
- Makes telescope and conical crowns move smoothly
- Diluteable with water



Description	Content	REF
Bottle with brush	20 ml	605 069



Artiholder

Occlusion paper holder

- Straight execution (Miller tweezers)
- Stainless steel

Description	REF
Artiholder	355 300



Cerami-Cut

Ceramic discs

- Very thin blades with 22 mm diameter
- Available in two thicknesses
- Box with 25 pieces each

Description	Thickness	Ø	REF
Cerami-Cut I	0.38 mm	22 mm	503 300
Cerami-Cut II	0.22 mm	22 mm	503 301



Corund SC

Long-lasting grinding material

- In the grain sizes 80 – 220
- The sharp grain preserves long and abrades slowly
- On 15 mm wide roles, used with slot-mandrills

Description	Length	Grain size	REF
Corund SC Nr. 80	25 m	80	605 016
Corund SC Nr. 100	30 m	100	605 017
Corund SC Nr. 120	30 m	120	605 018
Corund SC Nr. 150	30 m	150	605 019
Corund SC Nr. 180	50 m	180	605 020
Corund SC Nr. 220	50 m	220	605 021



Vernax® 100

Insulating varnish, 100% of fine silver for stumps etc.

- Standardized grain size, shake before use
- Absolutely steady film of 8 – 10 µm (1 layer)
- Can also be applied in several layers
- Indissoluble against all isolating agents and evaporation
- Heat-proof during the deep drawing and by the use of diving wax
- Quick-drying
- Can be cleanly removed with acetone
- Recommended for full ceramic inlays and crowns etc. (e.g., Empress, Ivoclar)

Description	Content	REF
Bottle with brush	20 ml	605 063

Vernax® Antagon

Flimsy protection varnish

- For hardening of plaster surfaces (e.g. antagonists)
- Coat thickness approx. 3 – 4 µm
- Scratch- and wear-resistant
- Transparent and very quick-drying
- Also as the first layer under Vernax 100, Vernax S and Vernax G

Description	Content	REF
Pinselflasche	20 ml	605 067



Vernax® S/Vernax® G

Insulating varnishes for stumps etc.

- Silver- and golden-colored
- Even film of approx. 10 µm
- Contains metal powder of standardized grain size
- Indissoluble against isolating means and evaporation
- Heat-proof during the deep drawing and by the use of diving wax
- Quick-drying

Description	Content	REF
Vernax S (silver), bottle with brush	20 ml	605 065
Vernax G (gold), bottle with brush	20 ml	605 066

Vernax® Thinner

- Clear liquid to thin Vernax 100, Vernax S., Vernax G as well as Vernax Antagon

Description	Content	REF
Thinner	20 ml	605 068



Occlu® Spray Plus

High-quality green occlusion spray

- For marking of contact points by direct spraying onto the occlusion surface
- Micro powder coating for highest accuracy
- Metal nozzle for extra fine spray mist
- Powder layer can be easily removed with water
- Economic in consumption

Description	Color	Content	REF
Spray can	green	75 ml	554 205
Spray can	green	50 ml	554 211
Spray can	red	50 ml	554 215



Ask for our **Dentist Catalogue**

Request for further information

or visit us at the internet

Ask for ABC of articulation booklet



Combitec®

Whole metal ARCON articulator

- Excellent prize and achievement relation
- Usable with other articulators
- Bennett angulation and condyle orbit inclination variable adjustable
- Immediate side-shift movement
- Centric lock
- No disintegration of the articulator by special 3-point mounting
- Corner stand for optimum position to the eye – removable
- Strong recall spring for the final bite registration
- Possibility for the work in open position
- Retrusion-and protrusion device optionally
- Mounting plates for Combitec A optionally – see REF 203 204

Technical data:

Intercondylar distance: 110 mm
 Condyle inclination: 10.5°
 Incisal plate: 0°
 Condyle orbit: 0°–40°
 Bennett angulation: 0°–40°
 Incisal pin with mm division as well as incisal indicator

Scope of supply:

Combitec articulator A
 Incisal plate: 0°
 Condyle inclination: 10.5°
 Intercondylar distance: 110 mm



Set Of Mounting Plates

Only for Combitec A

Description	REF
Set of mounting plates, 1 pair (aluminium)	203 204

Description	Height	REF
Combitec Articulator A	116 mm	203 700
Combitec Articulator 2	110 mm	203 701
Combitec Articulator P	121 mm	203 702



Incisal Table Individual

Mounting plate for Combitec

- Individually and in mm distances adjustable from 0° – 45°
- Also for post preparing of available articulators

Description	REF
Incisal table individual	203 724

Incisal Table

Plastic (not pictured)

Description	REF
Incisal table, 10°	203 715
Incisal table, 20°	203 716
Incisal table, 30°	203 717



Retrusion/Protrusion

Retrusion brass blocks/protrusion brass blocks

Description	REF
- 0.5 mm	203 731
- 1.0 mm	203 726
- 1.5 mm	203 727
+ 1.0 mm	203 728
+ 2.0 mm	203 729
+ 3.0 mm	203 730

Ask for booklet: ABC of articulation

Balance

The classical NON-ARCON articulator

- Respectable, functional working device for complete and partial dentures as well as for crown and bridge works
- Worldwide the standard-Non-Arcon articulator
- Available in 3 construction heights: 95 mm, 105 mm, 116 mm (measurements without base plate)
- Joints and parts from stainless steel
- Torsion-resistant and free access to the model
- Extendable by numerous accessories as for example facial curve, foundation scales, calotte
- Mounting plates optionally (REF 203 204)

Technical data:

Condyle inclination:	25°
Incisal table:	5°
Bennett angulation:	0° bis 25°
Intercondylar distance:	100 mm

Scope of supply:

Articulator, incisal table, incisal pin, 2 mounting plates, rubber bands, Allen key

The balance is also specified with 20°, 30° or 40° condyles and available with 0°, 10° or 15° incisal plate

Description	REF
Balance 95	203 201
Balance 105	203 295
Balance 116	203 297



Mounting Plates

Aluminum with screw thread

Description	REF
Mounting plates, 1 pair	203 204

Balance De Luxe

The classical NON-ARCON articulator

- Individually adjustable condyle orbit inclination
- For individual preparations in full dentures as well as for crown and bridge technique
- Available in three construction heights: 95 mm, 105 mm, 116 mm (measurement without mounting plate)
- Joints and parts from high-grade steel
- Torsion-resistant and free access to the model, also from backwards
- Extendable by numerous accessories as for example facial curve

Technical data:

Condyle inclination:	-10° to + 70°
Incisal table:	5°
Bennett angulation:	0° to 25°
Intercondylar distance:	100 mm

Scope of supply:

Articulator with individually adjustable condyles, incisal table, incisal pin, 2 mounting plates, rubber bands, Allen key

Incisal table 0°, 10°, 15° separately available.

Description	REF
Balance De Luxe 95	203 202
Balance De Luxe 105	203 320
Balance De Luxe 116	203 322





Aperture Guide Pins

Description (bent for better viewing)	REF
95 mm	203 282
105 mm	203 284
116 mm	203 299

Incisal Guide Pins (no picture)

Description	REF
95 mm	203 241
105 mm	203 281
116 mm	203 269

Incisal Table (no picture)

Description	REF
0°	203 216
10°	203 218
15°	203 219

Condyles (no picture)

Description	REF
20°	203 222
25°	203 223
30°	203 224
40°	203 225

Individual Condyles -10° – +70° (variable)

Description	REF
rechts	203 226
links	203 229



Set-Up Table With Calotte (curve of SPEE)

- Up and down movement, one flat, one curved set-up plate
- Set with adapter an one plate each

Description	REF
Set-up table for Balance and Atomic F	203 205
Set-up table for Atomic B	203 105
Calotte plane	203 140
Calotte curved	203 141



Jüde Set-Up Table (all sides tiltable)

Precision table with ball joint

- Inclination angle is infinitely variable and can be adjusted to any direction
- Calotte set-up is possible even after adjustment of the models with the help of a face bow

Description	REF
Jüde Balance set-up table	203 209



Incisal Table Individual

New incisal table individual for Balance/Balance De Luxe

- Individually adjustable from 0° to 45°
- Set ring with mm-indication

Description	REF
Incisal table individual	203 327



Balance Pillar Set

To change over of existing Balance 95 and Balance De Luxe 95 articulators to the height of 105 mm or 116 mm

Description	REF
Balance on H 105 mm	203 235
Balance 95 mm on 116 mm	203 233
Balance De Luxe on H 105 mm	203 236
Balance De Luxe 95 mm on 116 mm	203 232

Balance Distance Rings

- Rings to increase existing Balance 95 and Balance De Luxe 95 articulators to the height of 105 mm or 116 mm
- Set with 2 rings, 2 screws, 1 guide pin and 1 adjusting aid
- Available upon request: Distance rings for RATIONAL

Description	REF
At 10 mm to 105 mm	203 203
At 21 mm to 116 mm	203 240

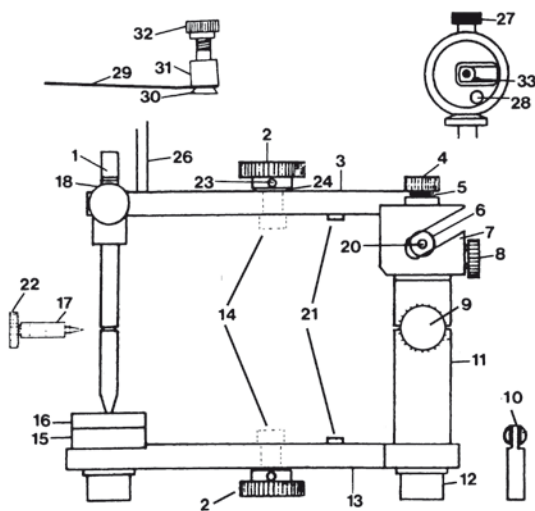

Balance Spare Parts

		REF
1a	Incisal Pin for 95 mm	(B + D) 203241
1b	Incisal Pin for 105 mm	(B + D) 203281
1c	Incisal Pin for 106 mm	(B + D) 203259
1d	Incisal Pin for 116 mm	(B + D) 203269
2	Model Support Screw	(B + D) 203242
3	Articulator Upper Part complete	(B) 203243
3	Articulator Upper Part complete	(D) 203272
4a	Clip-Clap Screw, Regular	(B) 203244
4b	Clip-Clap Screw, Long for 40° Condyle	(B) 203271
5	Counter-Spring	(B) 203245
6	Condyle Ball	(B+D) 203246

7	Condyle Element 25°	(B)	203223
8	¾ Fixing Screw	(B)	203248
9	Round fixing Screw (new)	(B+D)	203293
10	Fixing Lever	(B+D)	203249
11a	Pillar Right-hand (indicate length)	(B)	-
11b	Pillar Left-hand (indicate length)	(B)	-
11a	Pillar Right-hand (indicate length)	(D)	-
11b	Pillar Left-hand (indicate length)	(D)	-
12a	Foot 6 mm (regular)	(B+D)	203252
12b	Foot 8 mm (old)	(B+D)	203267
13	Articulator Lower Part	(B+D)	203253
14	Brass Screw	(B+D)	203254
15	Incisal Plate Holder	(B+D)	203255
16	Incisal Plate 5°	(B+D)	203217
17a	Incisal Indicator, Long (regular)	(B+D)	203257
17b	Incisal Indicator, Long (old)	(B+D)	203285
18	Set Screw	(B+D)	203258
20	Condyle Axle (ball included)	(B+D)	203260
21	Guiding Groove	(B+D)	203261
22	Fixing Screw	(B+D)	203262
23	Cross Screw	(B+D)	203263
24	Lower Washer	(B+D)	203264
25	Allen Key	(B+D)	203265
26a	Support Pin 92 mm	(B+D)	203266
26b	Support Pin 113 mm	(B+D)	203268
26c	Support Pin 138 mm	(B+D)	203319
27	Set Screw for Condyle	(D)	203274
28	Set Screw for Condyle Ball	(D)	203275
29	Orbital Plate	(D)	203276
30	Screw for Orbital Plate	(D)	203277
31	Orbital Holder	(D)	203278
32	Screw for Orbital Holder	(D)	203279
33	Condyle Ball Retention	(D)	203280

B = Balance, D = Balance de Luxe



Combitec® Facebow

One hand facebow with fast lock

- For fast and precise cast transfer in the Combitec articulator
- Easy handling as the joints can be fixed by hand
- Optimal adjustment to the Frankfurter horizontal plane by a new type of horizontally and vertically adjustable Glabella support
- The transfer part with bite fork impression can immediately be transferred into our articulators (without facebow)
- An exact three-dimensional model assignment can be achieved in the articulator
- High-quality, flat aluminum carry case
- Precise foamed plastic insert for a safe transport

Set:

Scissor bow and Glabella support
Transfer set and bite fork
Combitec adapter set

Description	Height	REF
Combitec facebow A for Combitec A	116 mm	203 708
Combitec facebow P for Combitec P	121 mm	203 709
Combitec facebow 2 for Combitec 2	106 mm	203 710
Transfer part for Combitec 2 (with bite fork)	100 mm	203 712
Transfer part for Combitec A (with bite fork)	116 mm	203 713
Transfer part for Combitec P (with bite fork)	121 mm	203 714
Single bite fork		203 711
Glabella support		203 725

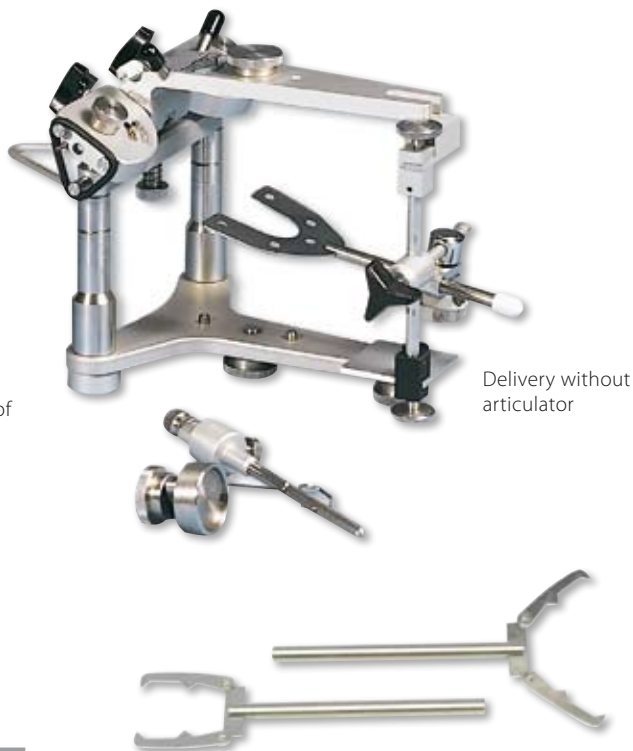

Delivery without articulator

Flexible Bite Fork

- With movable bite prongs
- For small and large jaws

Description	REF
Flexible bite fork	203 333



Combitec adapter optionally available

Adapterset

Transfer adapter for use with other articulators

Description	REF
Adapter set for Artex	203 718
Adapter set for S2/SP	203 719
Adapter set for Balance 116	203 720



Delivery without articulator

Combitec® Support Device

For other facebows

Description	REF
at Combitec 2	203 723
at Combitec A	203 721
at Combitec P	203 722

Balance Facebow

One hand facebow with fast-lock

- For fast and precise cast transfer for the Balance / Balance De Luxe
- Easy handling as the joints can be fixed by hand
- Optimal adjustment to the Frankfurt Horizontal plane by a new type of horizontally and vertically adjustable Glabella support
- The transfer part with bite fork impression can immediately be transferred into our articulators (without facebow)
- An exact three-dimensional model assignment can be achieved in the articulator
- Set in special aluminum carry case
- Precise foamed plastic insert for a safe transport

Scope of supply:

Scissor bow and Glabella support
Transfer part and bite fork
Balance adapter set

- Facebow stays in the practice
- Transfer part with impression has to be given to the lab
- Transfer adapter for Balance articulator stays in the lab



Delivery without articulator

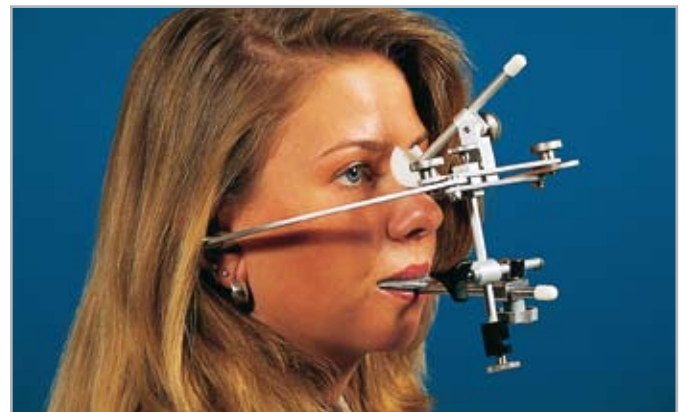

Description	REF
Balance facebow, height 95 mm	203 228
Balance facebow, height 105 mm	203 330
Balance facebow, height 116 mm	203 332
Transfer part and bite fork extra, height 95 mm	203 287
Transfer part and bite fork extra, height 105 mm	203 334
Transfer part and bite fork extra, height 116 mm	203 331
Single bite fork	203 711
Single adapter set	203 288



Atomic B

Main value articulator

- Height 95 mm
- Inclination of condylar path 25°
- Quick removal of models by practical lever lock
- Stable, light-weight, handy
- Grey/blue finish

Description	REF
Articulator with 2 mounting plates, incisal pin, incisal table 10 °C and Allen key	203 101



Mounting Plates (Atomic B)

Aluminum mounting plates

Description	REF
Aluminium Sockelplatten, ein Paar	203 102



Set-Up Device/Calotte

2 set-up plates + 1 holder

- Can be adjusted up and down
- 1 plane calotte and 1 curved calotte (SPEE-curve)
- For the fast set-up of full dentures

Description	REF
Set-up table for balance and Atomic F	203 205
Set-up table for Atomic B	203 105
Calotte plane	203 140
Calotte curved	203 141

Balance Split-Cast F

Description	REF
2 magnetic mounting plates and 10 metal insert discs	203 211
10 extra metal insert discs	203 212

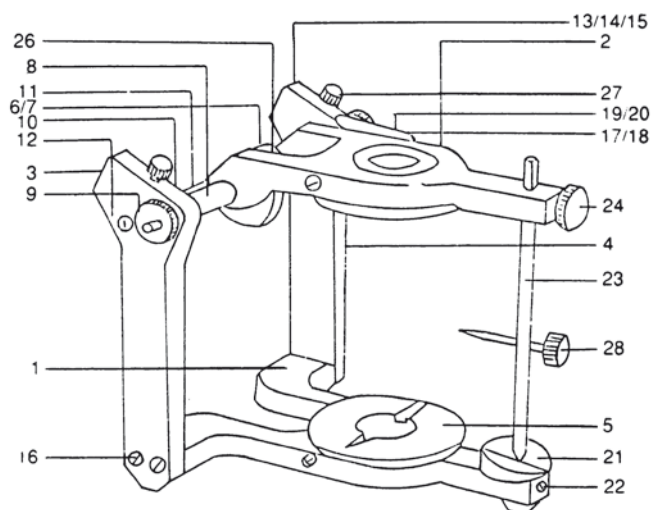

Atomic Spare Parts

	REF		REF
1 Lower Arm	203114	13 Spring Bolt	203125
2 Upper Arm	203115	14 Spring	203126
3 Right Column, short	203116	15 Set Screw (M6 x 6)	203127
Right Column, long	203158	16 Screw (M4 x 15)	203128
4 Left Column, short	203117	17 - 20 Fixing Lever UJ	203129
Left Column, long	203159	17 - 20 Fixing Lever LJ	203144
5 Mounting Plate	203102	21 Incisal Guide Plate	203130
6 Stopper	203118	22 Set Screw (m5x6)	203131
7 Set Screw (M6 x 6)	203119	23 Incisal Guide Pin	203132
8 Main Shaft	203120	24 Stop Screw	203133
9 Pivot	203121	25 Key	203134
10 Plastic Bushing	203122	26 Set Screw (M4x6)	203135
11 Stay	203123	27 Centric Screw	203136
12 Screw (M3 x 15)	203124	28 Incisal Pin (only deliverable with No 23)	



Airsonic® Adapter

Description	REF
a.) Adapter K for a direct connect to Kavo unit	401 084
b.) Adapter S for a direct connection to Sirona Titane unit	401 089
c.) Connection to W + H Rotoquick	401 077
d.) Connection to Bien Air Unifix	401 076
e.) Connection to EMS-box	401 090
f.) Connection to lab unit	401 091

Airsonic® Mini Sandblaster

Handy sandblaster

- For roughening bonding surfaces of crowns, bridges, brackets, posts, etc.
- Thoroughly roughened bonding surfaces for optimal bonding of various materials
- Ideal for all metals and ceramics
- Also suitable for the removal of cement residues from crowns and bridges

Description	REF
Sandblaster with standard nozzle 60° and 20 g powder (50 µm)	401 080
Single 60° nozzle	401 086



Airsonic® Absorbo Box

Handy absorbing box – new model

- Portable dust collector – the abraded material remains in the box and is completely collected in the filter
- Very low-noise and high-performance device
- Solid and durable design
- Problem-free cleaning by removable filter

Description	REF
Airsonic Absorbo Box	401 082
Replacement filter separately	401 092
Replacement pane available on request	

Airsonic® Alu-Oxide



Aluminium powder for sandblasting

Description	REF
Airsonic Alu-Oxide, 50 µm, 500 g	605 084
Airsonic Alu-Oxide, 90 µm, 500 g	605 086



- No separate aspiration system required
- Ideal for working in combination with the mini sandblaster
- Size (W x H x D): 35.6 cm x 22 cm x 37 cm
- Weight: Only 2.8 kg

Equipment available on request.

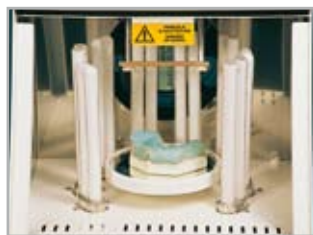

Speed Labolight

Universal light polymerization device

- For all light-curing dental materials
- Nanometer spectrum 320–550 nm
- Optimized light mixture for a homogenous and safe curing
- Circular arrangement of eight rod lamps around a turntable (dia. 14 cm) and one halogen lamp
- Interval turntable for an evenly light impact and curing
- Adjustable from one second to 99 minutes, protection against overheating, polymerization temperature in the chamber does not exceed 40 °C
- Durable (approx. 1,000 hours), easy-to-exchange lamps
- Acoustic signal indicates end of polymerization
- Operating hours counter

Technical data

Supply voltage:	230 V, 50 Hz
Power consumption:	225 W
Fuse:	1 x 2.5 A
Lamps:	8 x 9 W T1 (white light) 4 x 9 W T8 (UV-A) 1 x 150 W (halogen)
Size (W x H x D):	250 x 290 x 240 mm
Weight:	7 kg
Turntable:	Ø 14 cm

Description	REF
Unit incl. 13 lamps	401 125



Separate single lam:

Description	REF
T1 (white light)	901 002
T8 (UV-A)	901 003
Halogen	901 004
Set (4 x T1 and T8, 1 x halogen each)	901 001



Speed Multipol

Light and hot air polymerization device

For the extra-oral light and heat treatment of crown and bridge material on composite basis (e. g. Estenia)

Heat chamber

- Individually adjustable up to 180 °C
- Digital clock with countdown (1 second up to 90 minutes)
- Big polymerization chamber

Light chamber

- Digital clock with countdown (1 second up to 99 minutes)
- The end of the cycle is announced by an acoustic signal
- Overheat protection
- Low polymerization temperature
- Interval turntable / 2 x 250 W halogen lamps

Technical data

Size (W x H x D):	33 x 47 x 29 cm
Weight:	ca. 13.5 kg

Description	REF
Speed Multipol	401 121





Mirator 2000

Electronically adjustable vibrator

Technical data	Mirator 2000
Handy worktop:	Approx. 160 x 155 mm
Supply voltage:	220/240 V 50/60 Hz
Power consumption:	Max. 100 W
Safety fuse:	2 A
Weight:	3 kg

Description	REF
Mirator 2000	401 344



Praxipol PS

Pressure polymerization vessel

- Approx. 4 l content
- For hot and cold polymerization
- Incl. inlet valve, pressure gauge and safety valve (GS/TÜV approved)
- Nonstick layer inside to avoid corrosion
- Weight: Approx. 2.5 kg only

Description	REF
Praxipol PS	401 400
Additional hose with coupling, length: 2 m	401 401
Additional hose SP with ball valve, length: 2 m	401 402



Weight 300 g

Bravo Portable II

Strong portable micro motor

- Allows working without wall socket, ideal for house calls (weight 300 g)
- Rechargeable battery, recharging time six hours, rechargeability of batteries 500 x and more, approx. 8 hours pure working time
- Infinitely variable motor with backward- and forward-running of 0–25.000 rpm
- Suitable for any standard hand and contra-angles piece with plane shaft without intra-spray and without light conductor
- May be attached to the belt, space-saving
- Only for extra oral use

Description	REF
Motor, unit holder and recharger (220 V)	452 102



Fußanlasser

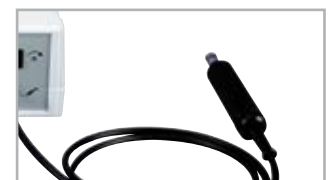

Drehstrommotor



Bravo TD III

AC Motor (3-Phase-Motor) – new case

- For all commercial handpieces and contra-angles with plane shaft
- Speed variable and precise adjustable from 1.000–30.000 rpm
- Forward and reverse rotation, with optic indication
- Solid, low-maintenance plastic body

Technical data

Supply voltage:	230 V
Motor capacity:	Max. 40 W
Size (H x W x D):	18.5 x 8.8 x 18.8 cm
Weight:	Approx.: 2.5 kg

Description	REF
Bravo TD III	452 106



Speedo-Clean®

Low-noise denture cleaning device

- Cleans surfaces using rotating polishing needles in combination with a cleaning liquid – no material abrasion
- Optimal cleaning as the needles reach every interdental space
- Integrated timer allows individual cleaning times
- Additional magnet keeps the needles in the container when replacing the liquid
- Autoclavable

Technical Data

Weight:	2 kg	Frequency:	50/60 Hz
Output:	35 W	Rotation:	1.700 rpm
Supply voltage:	230 V		

Article	REF
Device with container, 50 g polishing needles (Ø 0.6 mm) 1 litre of liquid and 1 magnet	401 136
50 g polishing needles, nickel-free stainless steel Ø 0.6 mm for dentures	304 014
Ø 0.8 mm for telescopic work or similar	304 013
Speedo-Clean liquid, 1 litre	554 106
Container separately	355 419



McTooth® Mirror

Molar-shaped prop-up mirror

- Size approx. 17 cm x 14 cm

Description	REF
McTooth mirror	707 094



Praxipolish® Plus

Cleaning foam for office and lab

- Additionally gives a satin shine
- Removes dirt, dirt rims, stains, etc.
- Bactericidal and disinfecting
- Fights all gram-positive and gram-negative bacteria, fungi and viruses reliably
- Effectiveness tested by the neutral German "Institute for Hospital Hygiene and Infection Control" IKI Gießen

Praxipolish®

Cleaning foam, classic since 40 years

- Removes dirt, dirt rims, stains, etc.
- Gives additional satin shine
- For devices, plastic and wooden surfaces, etc.

Description	REF
Praxipolish Plus, 400 ml	554 208
Praxipolish, 400 ml	554 207



Protho Clean®

Fully synthetic maintenance agent for the cleaning of acrylic resin dentures

- Upgrades the presentation of your prosthetic work
- For the removal of polishing agent and monomer residues from prosthetic work
- Spray on and wipe off with a soft cloth

Description	REF
Protho Clean, 75 ml	554 220



Orange-Solvent®

Cleaning solution on the basis of natural orange oil

- For the removal of impression pastes, zinc oxide cements, dispersion adhesive (stickers, labels) from instruments and hands
- Ideal for the cleaning of stainless steel
- Surfaces become shiny and are protected
- Can be removed with water, fresh orange flavor
- Non-toxic product on the basis of natural ingredients
- Available as solution and spray

Description	REF
Orange Solvent liquid, 250 ml	554 102
Orange Solvent spray, 200 ml	554 201



Mirawet® (instead of tap-water)

Disinfecting mixing liquid for all kinds of pumice powder

- Keeps the polishing compound creamy all day long
- Excellent bactericidal, fungicidal and tuberculocidal effect
- Virus-deactivating, effective against HBV and HIV viruses
- Skin-protecting, pH-neutral
- Biologically degradable and free from formaldehyde

Description	REF
Mirawet, 5 liter (5 kilo)	554 105



Algilock® Cleaner Plus

Alginate remover

- Cleaning in immersion bath without mechanic impact, no ultrasound, no scratching, etc.
- Decomposes the organic structure of the material, no aggressive or caustic effect
- pH-neutral and bio-degradable, pleasant odor, phosphate-free
- Sufficient for approx. 500 trays

Removes plaster and alginates easily from impression trays, instruments and spatulas. No laborious and time-consuming cleaning, simply add 50 g to one liter of warm water and leave for approx. 15 – 30 minutes. Can also be used in an ultrasonic unit. Not suitable for aluminium trays.

Description	REF
Algilock Cleaner Plus, 1.000 g	554 104



Tong-Clin Gel

Tongue cleaning gel with a gentle and nurturing cleaning effect

- Removes tongue coatings gently
- Nurtures with camomile, sage and calendula
- Antibacterial and anti-inflammatory
- Long-lasting feeling of freshness
- Without alcohol

Article	Content	REF
Tong-Clin gel	50 ml	630 059
Tong-Clin set	Tongue cleaner + 50 ml gel	631 060



SCAN ME



Video



Tong-Clin De Luxe®

Tongue cleaner

- Dual function in one instrument
- Bristle field with short, rounded bristles lifts off tongue coatings
- Tongue scraper removes the loosened coatings subsequently
- Angled, flat arched top reduces gag reflex
- Handy finger-grip handle with protective cap

Article	REF
Blue transparent	631 029
Pink transparent	631 030



Zahnpick

Convenient combination of dental floss and toothpick

- 30 pcs.: handy dispenser box, 100 pcs.: individually blister-packed

Article	Content	REF
Zahnpick, dispenser box	30 pcs.	630 039
Zahnpick, blister-packed	100 pcs.	605 637



McTooth® Clip

Our McTooth as practical little helper for important messages

Description	REF
McTooth Clip	707 088



Protho Box®

Waterproof lockable denture box

- For simultaneous storing and cleaning of the denture
- The denture can be stored in the cleaning solution
- For 2 dentures and 80 ml of liquid
- Also ideal for orthodontic braces
- Waterproof by special lock: No leak-out of cleaning solution
- Box contains a cleaning brush with bristles on both sides: white bristles for base surface, black bristles for crevices in the denture
- Brush compartment also for cleaning tablets
- With mirror and cover

Description	REF
Box incl. brush	605 900
Single brush	605 901



Protho Brush® De Luxe

Prosthesis brush

- With two brush heads: Large brush field for cleansing of outer prosthesis surfaces, and smaller brush field for the hard-to-reach inner sides
- Ergonomically shaped finger-grip handle

Article	REF
Blue transparent	631 024
Pink transparent	631 025

Dento Box II: Height 4 cm



Dento Box I: Height 2,5 cm

Dento Box I + II

Solid transport and storage box

- For dentures, orthodontic work, etc.
- Impact-proof, safe snap fit and small ventilation holes
- An ideal advertising medium with your name and address (from 500 pcs.)

Advertising print possible, please request our offer!

Description	Inhalt	REF
Dento Box I, white	12 pcs.	355 148
Dento Box II, white	10 pcs.	355 141
Dento Box II, blue	10 pcs.	355 142
Dento Box II, pink	10 pcs.	355 143



Easy withdrawal
without entangling

15–18 cm

Mirafloss® Implant chx

Antibacterial floss fibres from the roll

- 50 floss fibres (15 cm each), rolled up in a handy dispenser
- Stiff ends facilitate threading
- Fleecy centre part saturated with 0.2% chx
- Ideal for the cleaning of implants and bridges
- Available in two thicknesses: fine (Ø 1.5 mm) and medium (Ø 2.2 mm)

Article	REF
Fine (pink)	630 134
Medium (turquoise)	630 135



miradent Demo Box

Practice box for patient education

Content:

- Pic-Brush IP probe
- Pic-Brush holder
- Pic-Brush brushes (7 different diameters, 6 brushes each)
- I-Prox P holder
- I-Prox P brushes (4 brushes)
- Patient recommendation pad with 50 sheets

Article	REF
miradent Demo Box	635 026

Pic-Brush® IP Probe

Measuring probe for determination of interdental space size

- Decisively facilitates the selection of the optimal Pic-Brush for a gentle interdental cleaning
- Colour coding matching the Pic-Brush brushes
- With mm-scale for measuring the pocket depth
- Easily to clean, demountable, autoclavable

Article	REF
Pic-Brush IP Probe	605 785

Design		Ø of wire with coating	Ø in total
pink xx-fine		Ø 0.5 mm	Ø 1.5 mm
yellow x-fine		Ø 0.6 mm	Ø 1.8 mm
white fine		Ø 0.7 mm	Ø 2.0 mm
green medium		Ø 0.8 mm	Ø 2.2 mm
blue large		Ø 0.8 mm	Ø 3.0 mm
bordeaux x-large		Ø 0.8 mm	Ø 6.5 mm
orange conical		Ø 0.8 mm	Ø 2.5-5.0 mm



Pic-Brush® Replacement Brushes

In hygienic storage box or as practice refills

Article	6 pcs.	Refills 25 pcs, bag
Pink	631 013	607 060
Yellow	631 014	607 061
White	631 015	607 062
Green	631 016	607 063
Blue	631 017	607 064
Bordeaux	631 050	607 065
Orange	631 018	607 066
Assorted	-	-

SCAN ME



Video



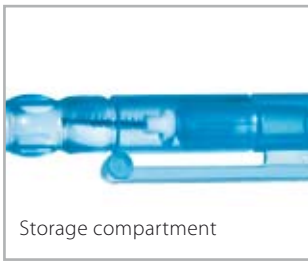

Storage compartment



SCAN ME



Video

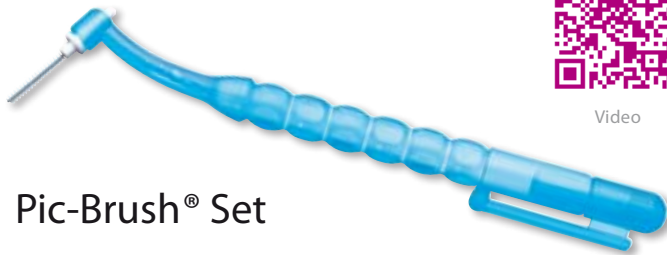

Pic-Brush® Set

Interdentary brush holder with one brush

- Connector system with conical neck for a safe fit
- Ergonomically shaped handle with 120° Pic angle
- Flexible high-quality brushes, coated special wire, ultra-fine bristles
- Protection against injuries due to elaborate loop technique of wire end
- Holder end with storage compartment for brushes and additional clip-on function
- Also for the cleaning of brackets, bridges and dentures

Article	Colour	REF
Holder with 1 brush	blue transparent	631 002
Holder with 1 brush	pink transparent	631 003
Holder with 1 brush	dark blue	631 001



SCAN ME



Video

Pic-Brush® Intro Kit

Interdentary brush holder with four brushes in four thicknesses

Article	Colour	REF
Holder with 4 brushes	blue transparent	631 005
Holder with 4 brushes	pink transparent	631 006
Holder with 4 brushes	dark blue	631 004



Molars



Brackets



Implants



Gingival pockets



Applications



Removal of plaque



SCAN ME



Video

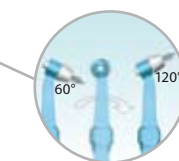

Switch Function

A push connection allows two different attachment angles for various possible applications

I-Prox® P

Pointed brush for precise use

- Efficient cleaning of gingival border and pockets with tapered bristle tuft
- Ideal for the cleaning of orthodontic appliances, implants and interdental spaces
- Optimal application of preparations
- Finger-grip handle (14 cm) with two click-on angles (60° and 120°)
- Holder end with storage compartment for brushes

Article	REF
Blue transparent	631 032
Pink transparent	631 033
Replacement brushes, 4 pcs.	631 034

I-Prox® Care Set

Interdentary care set

- For efficient cleaning of sulcus, interdental spaces and bridges
- Finger-grip handle allows safe and precise use
- Holder end of sulcus brush with storage compartment for replacement brushes
- Anti-fog coated mouth mirror for immediate self control

Set includes: miradent mouth mirror, I-Prox C double-ended toothscaler, I-Prox P sulcus brush

Article	REF
Blue transparent	630 160





21 g

uvex Super-Fit

Protective eyewear for best all-around view

- Great wrap-around lenses for a maximum field of view
- Pressure-free and comfortable to wear
- Very lightweight with 21 g
- Frame: white, lens: colorless

Coating: Outside extremely scratch-resistant, inside permanent anti-fog coating

Description	REF
uvex Super-Fit	304 428



21 g

uvex Super-Fit UV

UV protective eyewear

- Reliable protection against UV radiation in a wavelength range of 350 – 525 nm
- For all light polymerization units, against blue portion of halogen light
- Tested by NIOM (Nordic Institute of Dental Materials)
- Very lightweight with 21 g
- Frame: white, lens: orange

Coating: Outside extremely scratch-resistant, inside permanent anti-fog coating

Note: For cleaning of the lenses we recommend our product Astro Clean (REF 554 301)

Description	REF
uvex Super-Fit UV	304 427



40 g

uvex Skyguard

Safe eyewear with all-around protection

- Extremely tight fit with a high comfort through soft component
- Reliable protection against dust and particles
- Ideal for working with prophylaxis blasting devices
- Weight: 40 g
- Frame: blue (grey), lens: colorless

Coating: Outside extremely scratch-resistant, inside permanent anti-fog coating

Description	REF
uvex Skyguard NT	304 429



uvex I-VO

Fashionable multi-component protective eyewear

- High wearing comfort through multi-material manufacture (hard/soft components)
- High-quality, exchangeable lenses
- Brown lens with 3.000 UV SCT coating (100% UV protection and chemical-resistant)
- In two designs

Coating: Outside extremely scratch-resistant, inside permanent anti-fog coating

Frame	Lens	REF
I-VO "S" blue/orange	brown*	355 590
I-VO blue/grey	colorless	355 589
Replacement lens	colorless	355 591
Replacement lens	brown*	355 592



H&W Classic

Fashionable mono-lens eyeglasses from polycarbonate

- Soft temples, individually adjustable through integrated extension lock
- Clear lens with anti-fog and anti-scratch coating
- Side protection
- Weight 36 g

Description	REF
H&W Classic	355 622



H&W Panorama

Extremely lightweight and fashionable mono-lens eyeglasses from polycarbonate

- Temples ergonomically bent
- Nosepiece from soft and non-slip rubber
- Clear lens with anti-fog and anti-scratch coating
- Weight 22 g

Description	REF
H&W Panorama	355 620



H&W Featherlight

Extremely lightweight and fashionable mono-lens eyeglasses from polycarbonate

- Soft temples, individually adjustable through integrated extension lock
- Nosepiece from soft and non-slip rubber
- Clear lens with anti-fog and anti-scratch coating
- Weight 22 g

Description	REF
H&W Featherlight	355 621



H&W OTG – Over The Glasses

Mono-lens eyeglasses from polycarbonate ideal for spectacle wearers

- Ventilation system in the side protection
- Adjustable temple length
- Excellent protection for laboratory works
- Weight 41 g

Description	REF
H&W OTG	355 623



25 g



25 g



Proto-Cam

Face shield

- From non-reflecting polycarbonate
- With anti-fog coating
- Lightweight temple for fixing to the head
- Replaceable flip-up protection shield
- Fixable in different hinging positions
- Extremely lightweight, total weight only 25 g
- Ideal for works with prophylaxis units

Set with 5 replacement shields

Description	REF
White frame	355 535
Transparent blue frame	355 546
Set with 5 replacement shields	355 536

CC-Shield

Face protection shield

- Highly impact-proof, solid material
- Fixation by comfortable head band
- Fits any head size – adjustable Velcro
- Can be hinged upwards
- Anti-fog foil
- No light or color reflexes
- For working with blasting devices

Description	REF
CC-Shield	355 508



Only 37 g

uvex Super OTG (Over The Glasses)

Lightweight over-the-glass all-around protective eyewear

- Good coverage of the eye area by flat basic curve
- No contact of temples with the prescription glasses
- Soft, extra flexible temple tips
- 11° inclination allows a good downward view thus offering safety against accidents

Coating: Inside scratch-resistant and anti-fog, outside extremely scratch-resistant

Description	REF
uvex Super OTG	355 539



Astro Clean

Spray disinfection

- For disinfection of Uvex protective glasses (no harm of anti-fog foil)
- For all surfaces in the medical field
- Bactericidal, fungicidal and virus-inactivating (HBV and HIV)
- Free of formaldehyde

Description	REF
Astro Clean, 250 ml	554 301



Xylitol Chewing Gum

Dental care chewing gum with 100 % xylitol

- Reduction of caries incidence by up to 100 %
- Suitable for diabetics, without aspartame
- Fights xerostomia
- Gluten-free, spearmint and peppermint flavours contain menthol
- Promotional HV display made of acryl available on request

Reclosable box with 30 gums

Article	REF
Spearmint	630 079
Peppermint	630 080
Cinnamon	630 081
Fresh Fruit	630 082
Cranberry	630 090
Green Tea	630 091



Bulk box with 200 packs of 2 dragees each

Article	REF
Assorted	635 069



Toothfriendly!



Xylitol Powder

Xylitol – a 100 % natural and healthy sugar substitute

- For sweetening of cold and hot drinks, fruit, cereals or for baking
- Excellent for a balanced diet
- Same sweetening effect as sugar
- Purely natural product, gluten-free and not genetically modified
- 40% less calories than saccharose
- Suitable for diabetics in the context of a diet plan
- Reduces the number of plaque- and acid-forming bacteria
- 350 g pack with 87 single servings (teaspoon)

Article	Content	REF
Xylitol powder	350 g	630 119
Xylitol powder	100 x 4 g	630 120



Anti-Stress Tooth

Effective relaxation aid

- Effective relaxation aid
- While squeezing and pressing this tooth the patient will be diverted in a pleasant way
- Not only for the strained, nervous patient
- Dimensions: 60 x 60 x 65 mm
- Weight: 42 g
- Material: Polyurethane

Description	REF
Anti-Stress tooth	707 002



**Your partner for
ideas and service**



Hager & Werken GmbH & Co. KG
Postfach/P.O.B. 10 06 54 · 47006 Duisburg
Ackerstraße 1 · 47269 Duisburg, Germany
Telefon +49 (203) 99269-0
Fax +49 (203) 299283
E-Mail info@hagerwerken.de
Internet www.hagerwerken.de

Please see our general terms and conditions
under www.hagerwerken.de

©08/2011 by Hager & Werken, Germany. Mistakes and printing errors are non binding.

2011071801